

## Dijital program şalteri DPS

TR Montaj kılavuzu

159861-01



**Germany**  
GEZE Sonderkonstruktionen GmbH  
Planken 1  
97944 Boxberg-Schweigern  
Tel. +49 (0) 7930 9294 0  
Fax +49 (0) 7930 9294 10  
E-Mail: sk.de@geze.com  
GEZE GmbH  
Niederlassung Süd-West  
Tel. +49 (0) 7152 203 594  
E-Mail: leonberg.de@geze.com  
GEZE GmbH  
Niederlassung Süd-Ost  
Tel. +49 (0) 7152 203 6440  
E-Mail: muenchen.de@geze.com  
GEZE GmbH  
Niederlassung Ost  
Tel. +49 (0) 7152 203 6840  
E-Mail: berlin.de@geze.com  
GEZE GmbH  
Niederlassung Mitte/Luxemburg  
Tel. +49 (0) 7152 203 6888  
E-Mail: frankfurt.de@geze.com  
GEZE GmbH  
Niederlassung West  
Tel. +49 (0) 7152 203 6770  
E-Mail: essen.de@geze.com  
GEZE GmbH  
Niederlassung Nord  
Tel. +49 (0) 7152 203 6600  
E-Mail: hamburg.de@geze.com  
GEZE Service GmbH  
Tel. +49 (0) 1802 923392  
E-Mail: service-info.de@geze.com

**Austria**  
GEZE Austria  
E-Mail: austria.at@geze.com  
www.geze.at

**Baltic States**  
GEZE GmbH Baltic States office  
E-Mail: office-latvia@geze.com  
www.geze.com

**Benelux**  
GEZE Benelux B.V.  
E-Mail: benelux.nl@geze.com  
www.geze.be  
www.geze.nl

**Bulgaria**  
GEZE Bulgaria - Trade  
E-Mail: office-bulgaria@geze.com  
www.geze.bg

**China**  
GEZE Industries (Tianjin) Co., Ltd.  
E-Mail: chinasales@geze.com.cn  
www.geze.com.cn  
GEZE Industries (Tianjin) Co., Ltd.  
Branch Office Shanghai  
E-Mail: chinasales@geze.com.cn  
www.geze.com.cn  
GEZE Industries (Tianjin) Co., Ltd.  
Branch Office Guangzhou  
E-Mail: chinasales@geze.com.cn  
www.geze.com.cn  
GEZE Industries (Tianjin) Co., Ltd.  
Branch Office Beijing  
E-Mail: chinasales@geze.com.cn  
www.geze.com.cn

**France**  
GEZE France S.A.R.L.  
E-Mail: france.fr@geze.com  
www.geze.fr

**Hungary**  
GEZE Hungary Kft.  
E-Mail: office-hungary@geze.com  
www.geze.hu

**Iberia**  
GEZE Iberia S.R.L.  
E-Mail: info@geze.es  
www.geze.es

**India**  
GEZE India Private Ltd.  
E-Mail: office-india@geze.com  
www.geze.in

**Italy**  
GEZE Italia S.r.l.  
E-Mail: italia.it@geze.com  
www.geze.it

GEZE Engineering Roma S.r.l.  
E-Mail: roma@geze.biz  
www.geze.it

**Poland**  
GEZE Polska Sp.z o.o.  
E-Mail: geze.pl@geze.com  
www.geze.pl

**Romania**  
GEZE Romania S.R.L.  
E-Mail: office-romania@geze.com  
www.geze.ro

**Russia**  
OOO GEZE RUS  
E-Mail: office-russia@geze.com  
www.geze.ru

**Scandinavia – Sweden**  
GEZE Scandinavia AB  
E-Mail: sverige.se@geze.com  
www.geze.se

**Scandinavia – Norway**  
GEZE Scandinavia AB avd. Norge  
E-Mail: norge.se@geze.com  
www.geze.no

**Scandinavia – Denmark**  
GEZE Danmark  
E-Mail: danmark.se@geze.com  
www.geze.dk

**Singapore**  
GEZE (Asia Pacific) Pte, Ltd.  
E-Mail: gezesea@geze.com.sg  
www.geze.com

**South Africa**  
GEZE Distributors (Pty) Ltd.  
E-Mail: info@gezesa.co.za  
www.geze.co.za

**Switzerland**  
GEZE Schweiz AG  
E-Mail: schweiz.ch@geze.com  
www.geze.ch

**Turkey**  
GEZE Kapi ve Pencere Sistemleri  
E-Mail: office-turkey@geze.com  
www.geze.com

**Ukraine**  
LLC GEZE Ukraine  
E-Mail: office-ukraine@geze.com  
www.geze.ua

**United Arab Emirates/GCC**  
GEZE Middle East  
E-Mail: gezeme@geze.com  
www.geze.ae

**United Kingdom**  
GEZE UK Ltd.  
E-Mail: info.uk@geze.com  
www.geze.com

## GEZE GmbH

Reinhold-Vöster-Straße 21–29  
71229 Leonberg  
Germany

Tel.: 0049 7152 203 0  
Fax: 0049 7152 203 310  
www.geze.com



## Seçenekler / Variants

| İsim                                                                                                 | Malz. No. |
|------------------------------------------------------------------------------------------------------|-----------|
| OFF tuşlu DPS Dijital program şalteri AS 500 1-kat çerçeve, alpin beyazı                             | 151524    |
| OFF tuşlu DPS Dijital program şalteri Anahtar tuşu SCT, 1 kutuplu AS 500 2-kat çerçeve, alpin beyazı | 155810    |
| OFF tuşu olmadan DPS Dijital program şalteri AS 500 1-kat çerçeve, alpin beyazı                      | 155809    |

## Aksesuar lar

| İsim                                          | Malz. No. |
|-----------------------------------------------|-----------|
| AS 500 UP çerçevesi                           |           |
| □ 1-kat                                       | 115376    |
| □ 2-kat                                       | 115377    |
| □ 3-kat                                       | 115378    |
| □ 4-kat                                       | 115379    |
| □ 5-kat                                       | 115380    |
| AS 500 Buton kasası                           |           |
| □ 1-kat                                       | 120503    |
| □ 2-kat                                       | 128609    |
| □ 3-kat                                       | 133206    |
| ST 550 alpin beyazı için ara çerçeve 55x55    | 155851    |
| LS 990 alpin beyazı için ara çerçeve 55x55    | 148997    |
| LS 990 paslanmaz çelik için ara çerçeve 55x55 | 131822    |
| AS 500 Kör kasa BAB                           | 118480    |
| Profil yarım silindirik                       | 090176    |
| Bağlantı kontağı                              | 024467    |

## Uygun şalter programları

- Jung
- AS 500
  - LS 990 (ara çerçevesi)
  - ST550 (ara çerçevesi)

### Merten

- Sistem M

### Berker

- B3
- B7
- S1

### Gira

- Standart 55
- E2
- Event

### Feller

- EDIZIOdue

## Teknik veriler

- Gerilim: 24 V DC
- Akım sarfiyatı: 60 mA
- Hat uzunluğu, maks.: 100 m
- Koruma türü: IP 40
- Depolama: -20 °C ... 85 °C  
Nemsiz ortamlarda
- Uygun çevre sıcaklığı: -15 °C ... 50 °C
- EMV parazit direnci aşağıdaki uyarınca: EN 61000-6-2

## Ölçü çizimleri

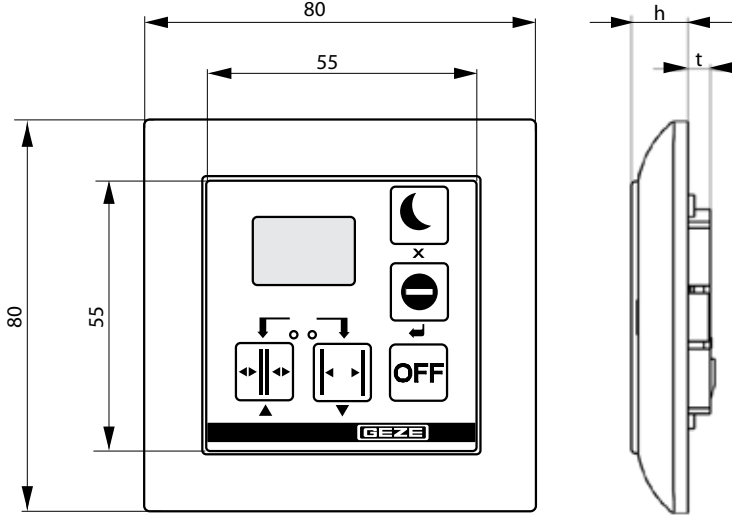

## Montaj

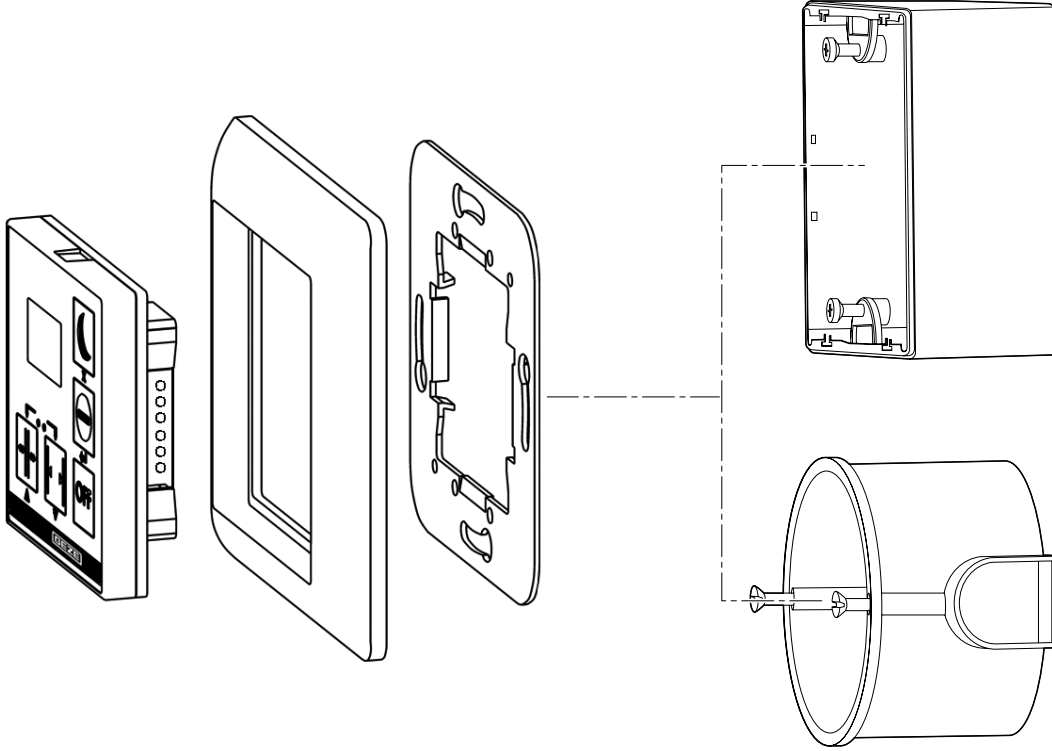

# Montaj desteği için şablon

- ! Kağıt şablonu ebatları havanın nemliliğine bağlı olarak değişiklik gösterebilir. Bundan dolayı sadece ebat verileri bağlayıcıdır.  
► Kullanmadan önce kağıt şablon ebatları kontrol edilmeli ve gerekirse düzeltilmelidir.

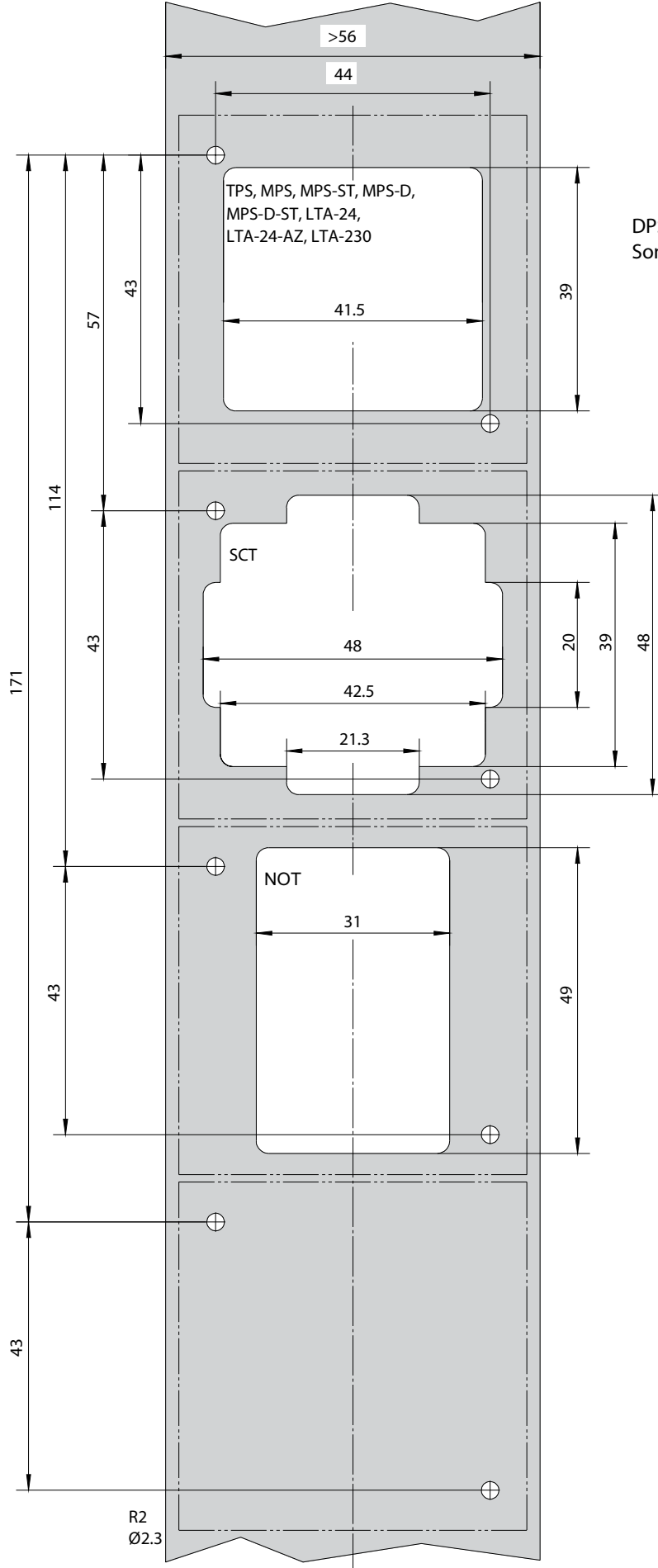

DPS, LTA-LSA:  
Sonradan montaj mümkün değil.

# Bağlantı planları

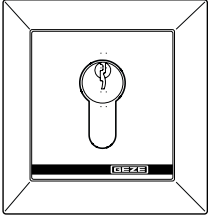
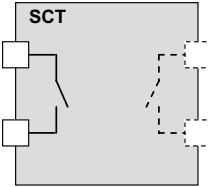
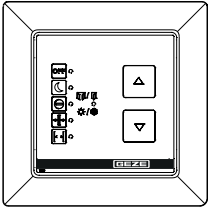
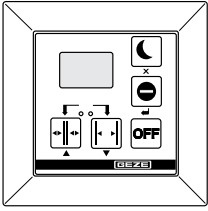
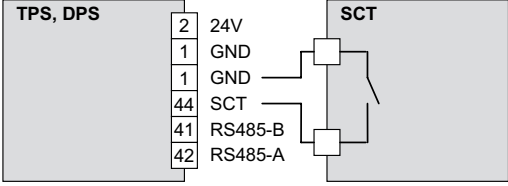
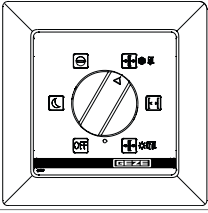
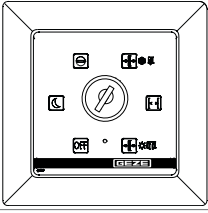
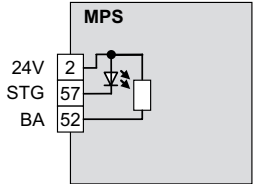
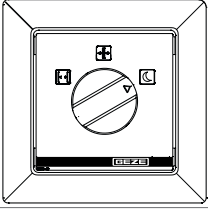
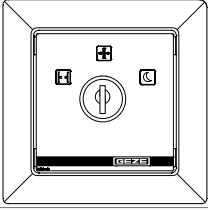
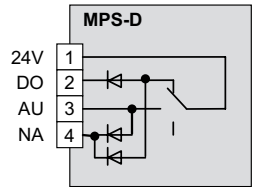
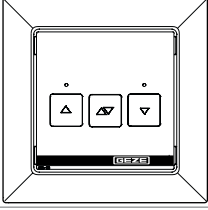
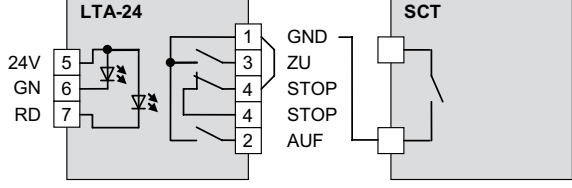
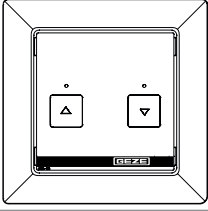
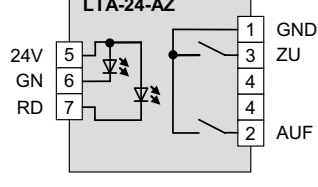
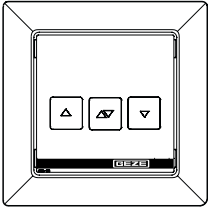
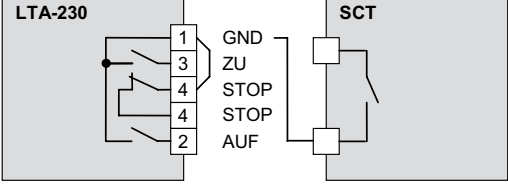
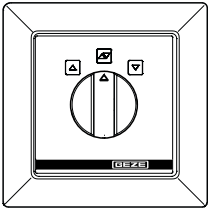
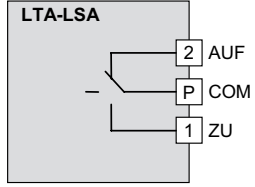
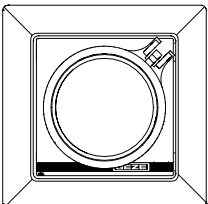
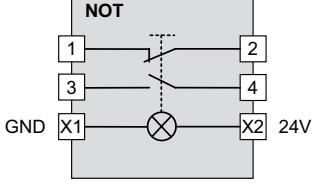
| Tuş                                                                                | Tanımlama                                                                                              | Malz. No. Tuş                                                      | Tanımlama                                                                          | Malz. No. | Bağlantı planı                                                                        | h [mm]                                                                               | t [mm]      |    |
|------------------------------------------------------------------------------------|--------------------------------------------------------------------------------------------------------|--------------------------------------------------------------------|------------------------------------------------------------------------------------|-----------|---------------------------------------------------------------------------------------|--------------------------------------------------------------------------------------|-------------|----|
|    | SCT (1-kutup)                                                                                          | 117996                                                             | -                                                                                  | -         |    | 11                                                                                   | 31.9        |    |
|    | TPS<br>TPS-SCT<br>TPS-KDT<br>TPS-KDT-SCT<br>DPS ile<br>OFF<br>DPS olmadan<br>OFF<br>DPS ile<br>OFF SCT | 113231<br>113232<br>126582<br>126583<br>151524<br>155809<br>155810 |   |           |     | 11.3                                                                                 | 5.3<br>31.9 |    |
|    | MPS                                                                                                    | 113226                                                             |   | MPS-ST    | 113227                                                                                |   | 24          | 36 |
|   | MPS-D                                                                                                  | 118417                                                             |  | MPS-D-ST  | 118418                                                                                |  | 24          | 36 |
|  | LTA-24<br>LTA-24-SCT                                                                                   | 118473<br>127176                                                   |                                                                                    |           |   | 11                                                                                   | 26          |    |
|  | LTA-24-AZ                                                                                              | 129393                                                             |                                                                                    |           |  | 11                                                                                   | 26          |    |
|  | LTA-230<br>LTA-230-SCT                                                                                 | 118474<br>118475                                                   |                                                                                    |           |   | 11                                                                                   | 26          |    |
|  | LTA-LSA                                                                                                | 118476                                                             |                                                                                    |           |  | 24                                                                                   | 32          |    |
|  | ACİL                                                                                                   | 123132                                                             |                                                                                    |           |  | 54                                                                                   | 56          |    |