

Tuşlu program şalteri

TR Kurulum talimatı

159809-04



Germany
GEZE GmbH
Niederlassung Süd-West
Tel. +49 (0) 7152 203 594
E-Mail: leonberg.de@geze.com
GEZE GmbH
Niederlassung Süd-Ost
Tel. +49 (0) 7152 203 6440
E-Mail: muenchen.de@geze.com
GEZE GmbH
Niederlassung Ost
Tel. +49 (0) 7152 203 6840
E-Mail: berlin.de@geze.com
GEZE GmbH
Niederlassung Mitte/Luxemburg
Tel. +49 (0) 7152 203 6888
E-Mail: frankfurt.de@geze.com
GEZE GmbH
Niederlassung West
Tel. +49 (0) 7152 203 6770
E-Mail: duesseldorf.de@geze.com
GEZE GmbH
Niederlassung Nord
Tel. +49 (0) 7152 203 6600
E-Mail: hamburg.de@geze.com
GEZE Service GmbH
Tel. +49 (0) 1802 923392
E-Mail: service-info.de@geze.com

Austria
GEZE Austria
E-Mail: austria.at@geze.com
www.geze.at
Baltic States
Lithuania / Latvia / Estonia
E-Mail: baltic-states@geze.com
Benelux
GEZE Benelux B.V.
E-Mail: benelux.nl@geze.com
www.geze.be
www.geze.nl
Bulgaria
GEZE Bulgaria - Trade
E-Mail: office-bulgaria@geze.com
www.geze.bg

China
GEZE Industries (Tianjin) Co., Ltd.
E-Mail: chinasales@geze.com.cn
www.geze.com.cn
GEZE Industries (Tianjin) Co., Ltd.
Branch Office Shanghai
E-Mail: chinasales@geze.com.cn
www.geze.com.cn
GEZE Industries (Tianjin) Co., Ltd.
Branch Office Guangzhou
E-Mail: chinasales@geze.com.cn
www.geze.com.cn
GEZE Industries (Tianjin) Co., Ltd.
Branch Office Beijing
E-Mail: chinasales@geze.com.cn
www.geze.com.cn
France
GEZE France S.A.R.L.
E-Mail: france.fr@geze.com
www.geze.fr

Hungary
GEZE Hungary Kft.
E-Mail: office-hungary@geze.com
www.geze.hu

Iberia
GEZE Iberia S.R.L.
E-Mail: info.es@geze.com
www.geze.es

India
GEZE India Private Ltd.
E-Mail: office-india@geze.com
www.geze.in

Italy
GEZE Italia S.r.l.
E-Mail: italia.it@geze.com
www.geze.it

GEZE Engineering Roma S.r.l.
E-Mail: italia.it@geze.com
www.geze.it

Korea
GEZE Korea Ltd.
E-Mail: info.kr@geze.com
www.geze.com

Poland
GEZE Polska Spz o.o.
E-Mail: geze.pl@geze.com
www.geze.pl

Romania
GEZE Romania S.R.L.
E-Mail: office-romania@geze.com
www.geze.ro

Russia
OOO GEZE RUS
E-Mail: office-russia@geze.com
www.geze.ru

Scandinavia Sweden
GEZE Scandinavia AB
E-Mail: sverige.se@geze.com
www.geze.se

Scandinavia Norway
GEZE Scandinavia AB avd. Norge
E-Mail: norge.se@geze.com
www.geze.no

Scandinavia Denmark
GEZE Danmark
E-Mail: danmark.se@geze.com
www.geze.dk

Singapore
GEZE (Asia Pacific) Pte, Ltd.
E-Mail: gezeasia@geze.com.sg
www.geze.com

South Africa
GEZE South Africa (Pty) Ltd.
E-Mail: info@geze.co.za
www.geze.co.za

Switzerland
GEZE Schweiz AG
E-Mail: schweiz.ch@geze.com
www.geze.ch

Turkey
GEZE Kapı ve Pencere Sistemleri
E-Mail: office-turkey@geze.com
www.geze.com

Ukraine
LLC GEZE Ukraine
E-Mail: office-ukraine@geze.com
www.geze.ua

United Arab Emirates/GCC
GEZE Middle East
E-Mail: gezeme@geze.com
www.geze.ae

United Kingdom
GEZE UK Ltd.
E-Mail: info.uk@geze.com
www.geze.com

GEZE GmbH

Reinhold-Vöster-Straße 21–29 Tel.: 0049 7152 203 0
71229 Leonberg Fax: 0049 7152 203 310
Germany www.geze.com



Uygun şalter programları

- Jung
- AS 500
 - LS 990 (ara kasalı)
 - ST550 (ara kasalı)
 - Merten
 - System M

Berker

- B3
- B7
- S1

Gira

- Standard 55
- E2
- Event

Feller

- EDIZIOdue

Terim

Otomatik kapı sistemlerinde çalışma modunun değiştirilmesi için tuşlu program şalteri.

- Tuşlu program şalteri, 1-kat kasalı AS 500 alpin beyazı, Malz. No. 113231
- Tuşlu program şalteri, anahtarlı buton, 1 kut. tek taraflı profil göbeği olmadan, 2-kat kasalı AS 500 alpin beyazı, Malz. No. 113232

Güvenlik uyarısı

Lütfen kapı motorunun güvenlik uyarılarını dikkate alın

Aksesuar

Ad	Malz. No.
AS 500 UP kasası	
□ 1-kat	115376
□ 2-kat	115377
□ 3-kat	115378
□ 4-kat	115379
□ 5-kat	115380
AS 500 sıva üstü montaj kutusu	
□ 1-kat	120503
□ 2-kat	128609
□ 3-kat	133206
ST 550 alpin beyaz için 55×55 ara kasa	155851
LS 990 alpin beyaz için 55×55 ara kasa	148997
LS 990 paslanmaz çelik için 55×55 ara kasa	131822
AS 500 kör kapak	115402
Tek taraflı profil göbeği	090176
Bağlantı kontağı	024467

Teknik özellikler

- Gerilim: 24 V DC
- Akım: 50 mA
- Hat uzunluğu, maks.: 100 m
- IP koruma sınıfı: IP 40
- Depolama: -20 °C ... 85 °C
Yoğuşma yok
- Çalışma sırasında çevre sıcaklığı: -15 °C ... 50 °C
- Aşağıdaki uyarınca elektromanyetik uyumluluk: EN 61000-6-2

Ölçü çizimleri

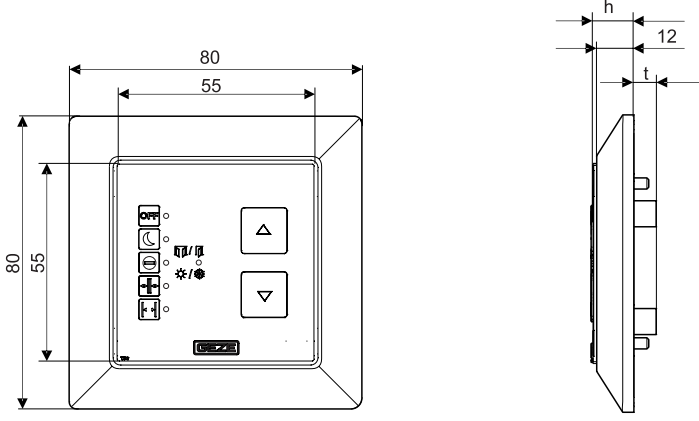

Montaj

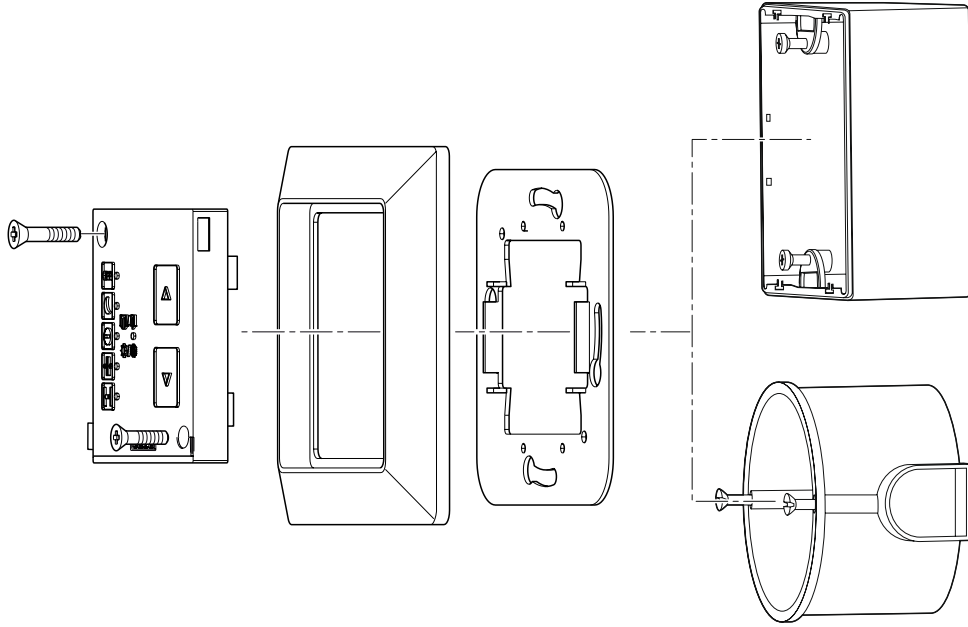

Devre şemaları

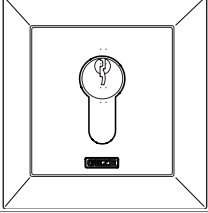
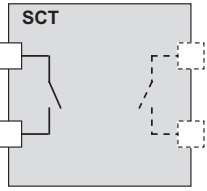
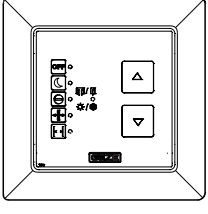
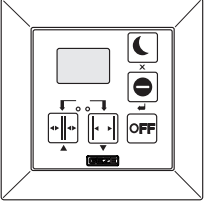
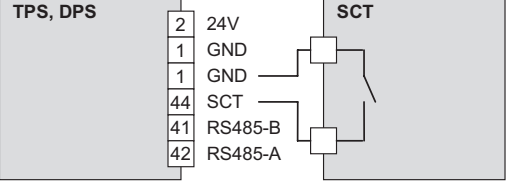
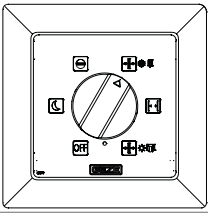
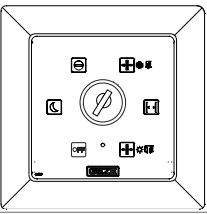
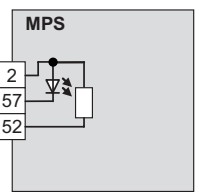
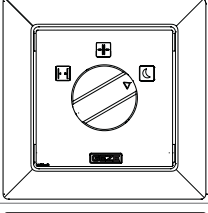
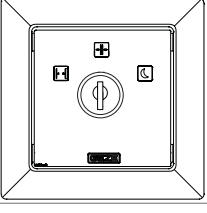
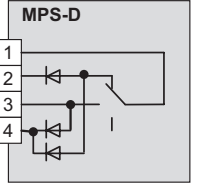
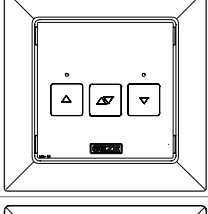
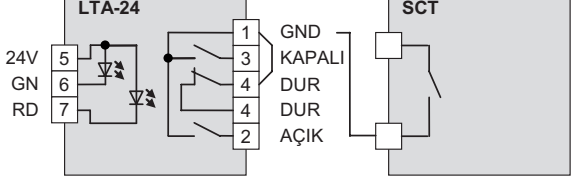
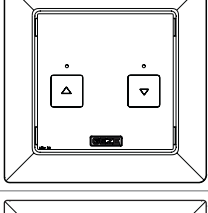
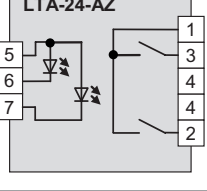
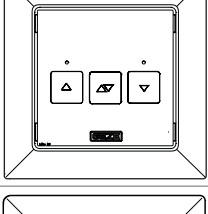
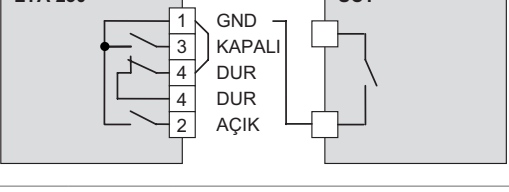
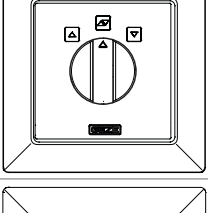
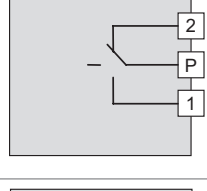
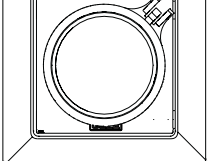
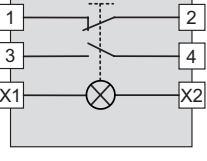
Basma buton	Terim	Malz. No.	Basma buton	Terim	Malz. No.	Devre şeması	h [mm]	t [mm]
	SCT (1-kut.)	117996		-	-		11	31,9
	Tuşlu program şalteri Tuşlu program şalteri- Anahtarlı buton Tuşlu program şalteri-Döner kapı Tuşlu program şalteri-Döner kapı- Anahtarlı buton Dijital program şalteri ile OFF Dijital program şalteri olmadan OFF Dijital program şalteri ile OFF	113231 113232 126582 126583 151524 155809 155810					11,3	5,3 31,9
	Mekanik program şalteri	113226		MPS-ST	113227		24	36
	MPS-D	118417		MPS-D-ST	118418		24	36
	LTA-24 LTA-24-SCT	118473 127176					11	26
	LTA-24-AZ	129393					11	26
	LTA-230 LTA-230-SCT	118474 118475					11	26
	LTA-LSA	118476					24	32
	ACİL	123132					54	56