

Manüel program şalteri MPS

TR Montaj kılavuzu

159822-03



Germany
GEZE Sonderkonstruktionen GmbH
Planken 1
97944 Boxberg-Schweigern
Tel. +49 (0) 7930 9294 0
Fax +49 (0) 7930 9294 10
E-Mail: sk.de@geze.com
GEZE GmbH
Niederlassung Süd-West
Tel. +49 (0) 7152 203 594
E-Mail: leonberg.de@geze.com
GEZE GmbH
Niederlassung Süd-Ost
Tel. +49 (0) 7152 203 6440
E-Mail: muenchen.de@geze.com
GEZE GmbH
Niederlassung Ost
Tel. +49 (0) 7152 203 6840
E-Mail: berlin.de@geze.com
GEZE GmbH
Niederlassung Mitte/Luxemburg
Tel. +49 (0) 7152 203 6888
E-Mail: frankfurt.de@geze.com
GEZE GmbH
Niederlassung West
Tel. +49 (0) 7152 203 6770
E-Mail: essen.de@geze.com
GEZE GmbH
Niederlassung Nord
Tel. +49 (0) 7152 203 6600
E-Mail: hamburg.de@geze.com
GEZE Service GmbH
Tel. +49 (0) 1802 923392
E-Mail: service-info.de@geze.com
Austria
GEZE Austria
E-Mail: austria.at@geze.com
www.geze.at
Baltic States
GEZE GmbH Baltic States office
E-Mail: office-latvia@geze.com
www.geze.com
Benelux
GEZE Benelux B.V.
E-Mail: benelux.nl@geze.com
www.geze.be
www.geze.nl
Bulgaria
GEZE Bulgaria - Trade
E-Mail: office-bulgaria@geze.com
www.geze.bg

China
GEZE Industries (Tianjin) Co., Ltd.
E-Mail: chinasales@geze.com.cn
www.geze.com.cn
GEZE Industries (Tianjin) Co., Ltd.
Branch Office Shanghai
E-Mail: chinasales@geze.com.cn
www.geze.com.cn
GEZE Industries (Tianjin) Co., Ltd.
Branch Office Guangzhou
E-Mail: chinasales@geze.com.cn
www.geze.com.cn
GEZE Industries (Tianjin) Co., Ltd.
Branch Office Beijing
E-Mail: chinasales@geze.com.cn
www.geze.com.cn
France
GEZE France S.A.R.L.
E-Mail: france.fr@geze.com
www.geze.fr
Hungary
GEZE Hungary Kft.
E-Mail: office-hungary@geze.com
www.geze.hu
Iberia
GEZE Iberia S.R.L.
E-Mail: info@geze.es
www.geze.es
India
GEZE India Private Ltd.
E-Mail: office-india@geze.com
www.geze.in
Italy
GEZE Italia S.r.l.
E-Mail: italia.it@geze.com
www.geze.it
GEZE Engineering Roma S.r.l.
E-Mail: roma@geze.biz
www.geze.it
Poland
GEZE Polska Sp.z o.o.
E-Mail: geze.pl@geze.com
www.geze.pl
Romania
GEZE Romania S.R.L.
E-Mail: office-romania@geze.com
www.geze.ro

Russia
OOO GEZE RUS
E-Mail: office-russia@geze.com
www.geze.ru
Scandinavia – Sweden
GEZE Scandinavia AB
E-Mail: sverige.se@geze.com
www.geze.se
Scandinavia – Norway
GEZE Scandinavia AB avd. Norge
E-Mail: norge.se@geze.com
www.geze.no
Scandinavia – Denmark
GEZE Danmark
E-Mail: danmark.se@geze.com
www.geze.dk
Singapore
GEZE (Asia Pacific) Pte, Ltd.
E-Mail: gezesea@geze.com.sg
www.geze.com
South Africa
GEZE Distributors (Pty) Ltd.
E-Mail: info@gezesa.co.za
www.geze.co.za
Switzerland
GEZE Schweiz AG
E-Mail: schweiz.ch@geze.com
www.geze.ch
Turkey
GEZE Kapi ve Pencere Sistemleri
E-Mail: office-turkey@geze.com
www.geze.com
Ukraine
LLC GEZE Ukraine
E-Mail: office-ukraine@geze.com
www.geze.ua
United Arab Emirates/GCC
GEZE Middle East
E-Mail: gezeme@geze.com
www.geze.ae
United Kingdom
GEZE UK Ltd.
E-Mail: info.uk@geze.com
www.geze.com

GEZE GmbH

Reinhold-Vöster-Straße 21–29
71229 Leonberg
Germany

Tel.: 0049 7152 203 0
Fax: 0049 7152 203 310
www.geze.com



Tanımlama

- Manüel program şalteri, döner düğme, 1-kat çerçeve AS 500 alpin beyazı, malz. No. 113226
- Manüel program şalteri, anahtar, 1-kat çerçeve AS 500 alpin beyazı, malz. No. 113227

Aksesuar

İsim	Malz. No.
AS 500 UP çerçevesi	
□ 1-kat	115376
□ 2-kat	115377
□ 3-kat	115378
□ 4-kat	115379
□ 5-kat	115380
AS 500 Buton kasası	
□ 1-kat	120503
□ 2-kat	128609
□ 3-kat	133206
ST 550 alpin beyazı için ara çerçeve 55×55	155851
LS 990 alpin beyazı için ara çerçeve 55×55	148997
LS 990 paslanmaz çelik için ara çerçeve 55×55	131822
AS 500 Kör kasa BAB	118480

Uygun şalter programları

- Jung
 - AS 500
 - LS 990 (ara çerçevesi)
 - ST550 (ara çerçevesi)

Merten

- Sistem M

Berker

- B3
- B7
- S1

Gira

- Standart 55
- E2
- Event

Feller

- EDIZIOdue

Teknik veriler

- Gerilim: 24 V DC
- Akım sarfiyatı: 50 mA
- Hat uzunluğu, maks.: 100 m
- Koruma türü: IP 40
- Depolama: -20 °C ... 85 °C
Nemsiz ortamlarda
- Uygun çevre sıcaklığı: -15 °C ... 50 °C
- EMV parazit direnci aşağıdaki uyarınca: EN 61000-6-2

Detay çizimleri

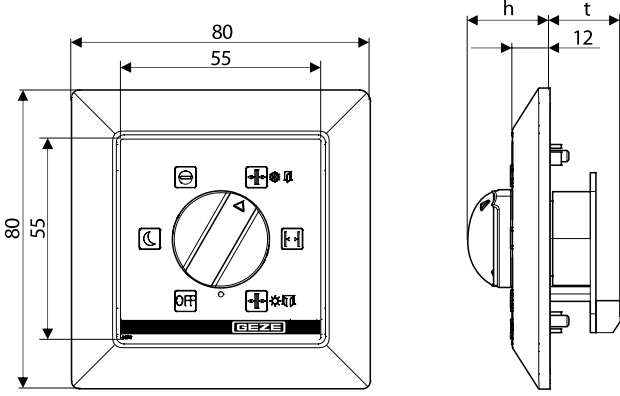

Montaj

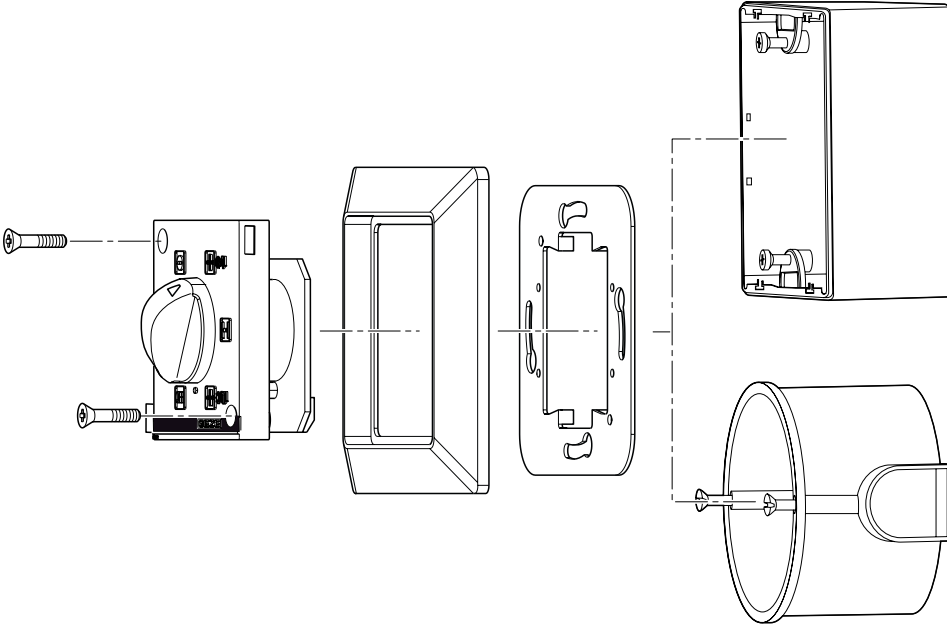

Montaj desteği için şablon



Kağıt şablonu ebatları havanın nemliliğine bağlı olarak değişiklik gösterebilir. Bundan dolayı sadece ebat verileri bağlayıcıdır.

► Kullanmadan önce kağıt şablon ebatları kontrol edilmeli ve gerekirse düzeltilmelidir.

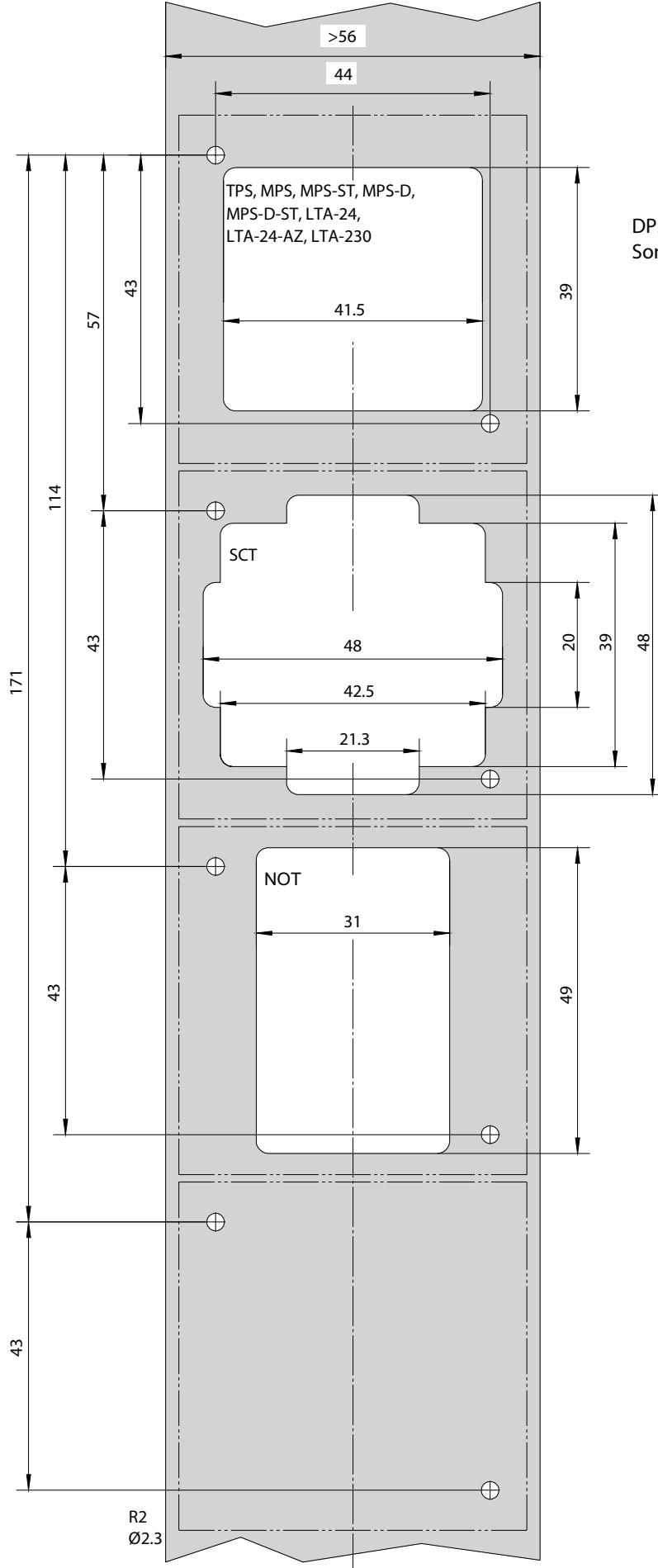

Bağlantı planları

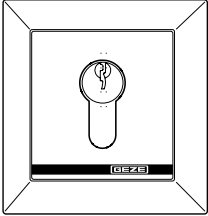
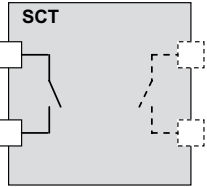
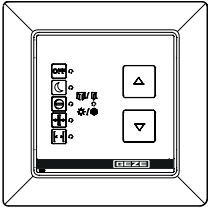
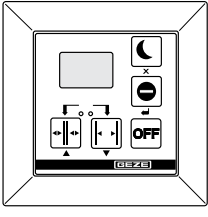
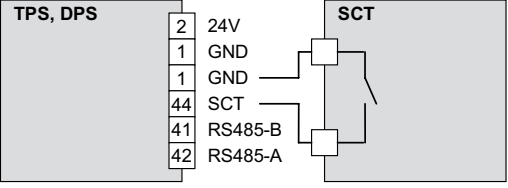
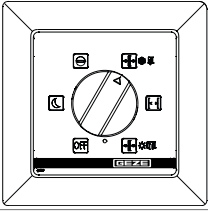
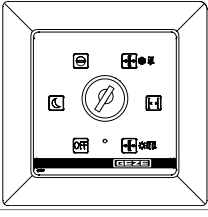
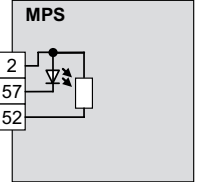
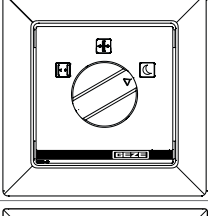
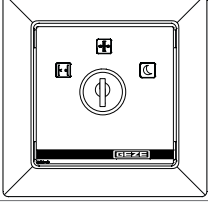
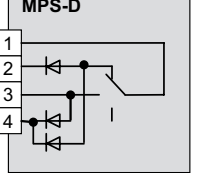
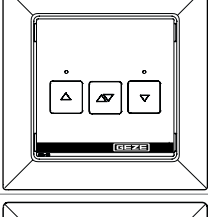
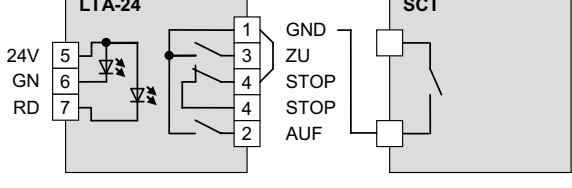
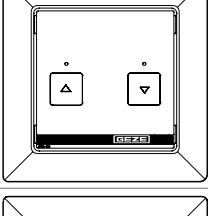
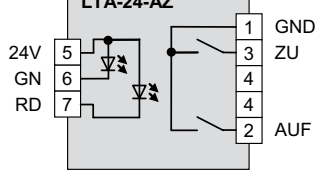
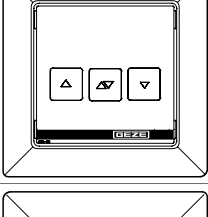
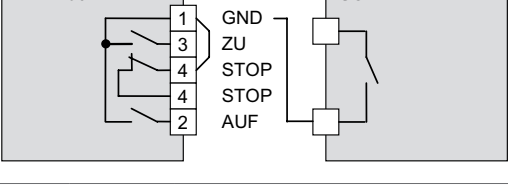
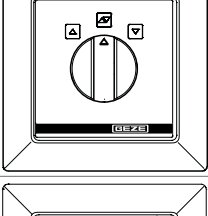
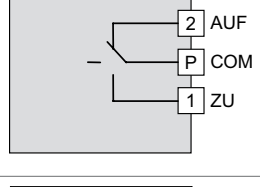
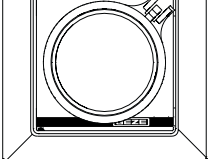
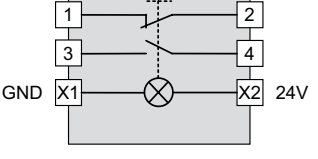
Tuş	Tanımlama	Malz. No. Tuş	Tanımlama	Malz. No.	Bağlantı planı	h [mm]	t [mm]	
	SCT (1-kutup)	117996	-	-		11	31.9	
	TPS TPS-SCT TPS-KDT TPS-KDT-SCT DPS ile OFF DPS olmadan OFF DPS ile OFF SCT	113231 113232 126582 126583 151524 155809 155810				11.3	5.3 31.9	
	MPS	113226		MPS-ST	113227		24	36
	MPS-D	118417		MPS-D-ST	118418		24	36
	LTA-24 LTA-24-SCT	118473 127176				11	26	
	LTA-24-AZ	129393				11	26	
	LTA-230 LTA-230-SCT	118474 118475				11	26	
	LTA-LSA	118476				24	32	
	ACİL	123132				54	56	